

STAINLESS STEEL CABINETS

HR-ESCTSL26 | ESSENCE

STAINLESS STEEL COUNTERTOP

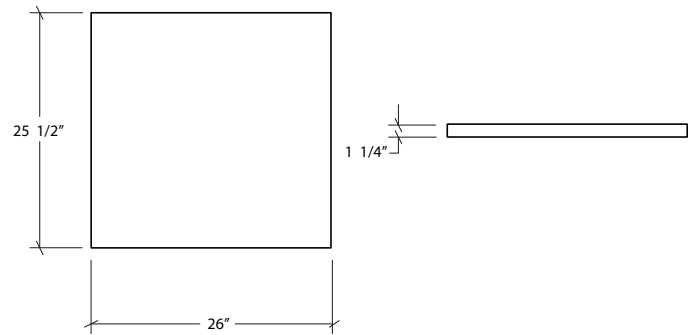
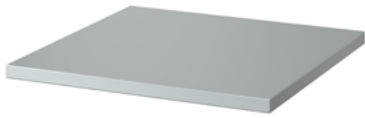

Specifications

Width	26"
Depth	25 1/2"
Thickness	1 1/4"
Material	304 Stainless Steel
Finish	Orbital
Installation	Assembly to Base
Packaging dimension	26.25 x 26 x 1.5"
Packaging Weight	19 lb

Features

- Convenient stainless steel countertop perfect for outdoor area.
- Modular system to be installed with ESSENCE cabinet.
- Long-lasting and easy maintenance.
- Proudly designed and made in Canada.

Warranty

Outdoor Refinements offers a LIMITED LIFETIME WARRANTY against defects of material and workmanship on the fixed components of its stainless steel cabinets, a PRORATED 10-YEAR LIMITED WARRANTY on painted finishes and a 2-YEARS LIMITED WARRANTY on all mobile parts and hardware (Hinges, slides, locks) all of which are applied following the purchase date. This warranty is limited to defects or damages resulting from a normal residential use. For further details on our product warranty, please refer to our catalog or Web site.