

005416 | SMARTSTATION® SET

UNDERMOUNT STAINLESS STEEL KITCHEN SINK AND ACCESSORIES

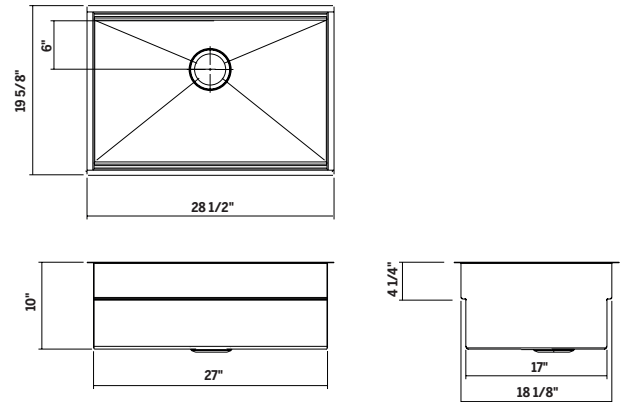

Specifications

Model	005416
Collection	SmartStation®
Bowl dimensions	27" x 18 1/8" x 10"
Overall dimensions	28 1/2" x 19 5/8" x 10"
Recommended cabinet	33"
Accessories handle material	Maple

Included accessories

Grid	200914
Cutting board	210068
Serving bin with bowls (4)	225315
Serving board with bowl and colander	225308
Drying rack	215307

Recommended accessories

Drain	100082
Colander	205325
Service bowls	225303
And many more	

Warranty

Home Refinements offers a LIMITED LIFETIME WARRANTY on the fixed components of its stainless steel sinks against defects of material and workmanship as well as a 1-YEAR LIMITED WARRANTY following the purchase date for all accessories against defects of material and workmanship. This warranty is limited to defects or damages resulting from a normal residential use. For further details on our product warranty, please refer to our catalog or Web site.

Features

- Handcrafted in Canada
- Commercial quality stainless steel 16 ga thickness
- Corrosion resistant material 304 series (18/10)
- Unique design allowing the Home Refinements standard accessories to slide one over the other on two levels
- Bottom ledge : 1/2" accessory ledge on front and back of the bowl to accommodate any Home Refinements accessory compatible with 17" bowl.
- Top Ledge : Home Refinements accessory compatible with 18" bowl to be used directly on the countertop (undermount with overhang 1/8" installation necessary)
- Many accessories included depending on the width of the sink to be used on accessory ledge or on the countertop (two (2) wood essences available: maple and american walnut)
- Bottom grid included to protect the surface of the sink
- Attractive combination of UrbanEdge® and J7® collections : vertical square corners [0mm] and slightly rounded corners [7mm] for bottom front and back folds
- Environmentally friendly product, 100% recyclable
- Elegant no. 4 brushed finish that matches the appliances
- Highly efficient sound deadening pads
- Practical flat sink bottom and straight bowl sides that maximize available space in the bowl
- Stylish and functional bowl bottom grooves that facilitate water drainage
- Rear or side 3-1/2" drain placement
- Mounting hardware included
- Certifications: ASME A112.19.3, CSA B45.0, CSA B45.4